



CHARACTERISTICS	
ENCODER TYPE	Shaft encoder
APPROVAL	II 2 G/D EEx d IIC T6
SMD - TECHNOLOGY	Strong compact electronics
HIGH IP-RATING	Std. IP 66
LOW CURRENT CONSUMPTION	To be connected directly to PLC'S and counters
SHORT CIRCUIT PROTECTION	Thermal shut down at 155°C
WIDE SUPPLY RANGE	Min. 4,5V to max. 30V
STRONG MEC. CONSTRUCTION	Based on 2 precision ball bearings, for harsh industrial environments

ELECTRICAL SPECIFICATIONS	
	At +25°C
Output waveform	Incremental (A, B)
Zero or index pulse	(Z) one pr./rev.
Output	Totempole
Supply-voltage (Vin)	Min 4,5V to Max. 30V * Reverse polarity protection
Current (no load)	Max. 45 mA
Max. load pr. output	30 mA - (Short circuit protected)*
V Out low	Max. 500 mV @ I = 10mA
Operating temp.	- 40°C to + 75°C
Storage temp.	- 40°C to + 75°C
Max. pulse frequency	300 kHz*
V out high	Min. (Vin -0,6) @ I = -10mA Min. (Vin -1,3) @ I = -25mA
Cable data	8 leads (0,14 mm ²)pairtwisted/shielded
Output signals	Standard, Inverted, Differential (RS-422A compatible)
EMC certified acc. to	EN 50081-1 and EN 50082-2
EEx certified acc. To	EN 50014 and EN 50018 and 94 / 9 / EC (ATEX)
	* = It is not recommended to combine max value for all 3 parameters

MECHANICAL SPECIFICATIONS	
Weight	About 540 g
Materials : Housing	Aluminum
Shaft	Stainless steel
Bearings	Lifetime lubricated ball bearings
Shaft dimensions	ø10 mm
Shaft loads	Axial max. 50 N Radial max. 50 N
Max. rev.	3.000 rev./min.
IP-rating	Standard IP 66
Start torque	IP 66 < 0,05 Nm at 25°C IP 67 < 0,2 Nm at 25°C IP 68 < 0,2 Nm at 25°C
Mass moment of inertia	35 gcm ²
Max. shock	100 G/11 ms
Bump	10 G - 16 ms (1000 x 3 Axis)
Vibration	(10 - 2000 Hz)/10 G

OUTPUT WAVEFORM

Rotation: Clockwise (cw) from shaftside
(inv = inverted channels)

channel A
channel A-inv
channel B
channel B-inv
channel Z (gated)
channel Z-inv (gated)

X = 180°e ± 36°e and Y = 90°e ± 18°e
Z puls: Gated with A and B (standard)

Options: TTL or HTL compatible. Open Collector NPN or PNP
Gated Z-puls or none-gated Z-puls.
View more Output options 52 - page 1

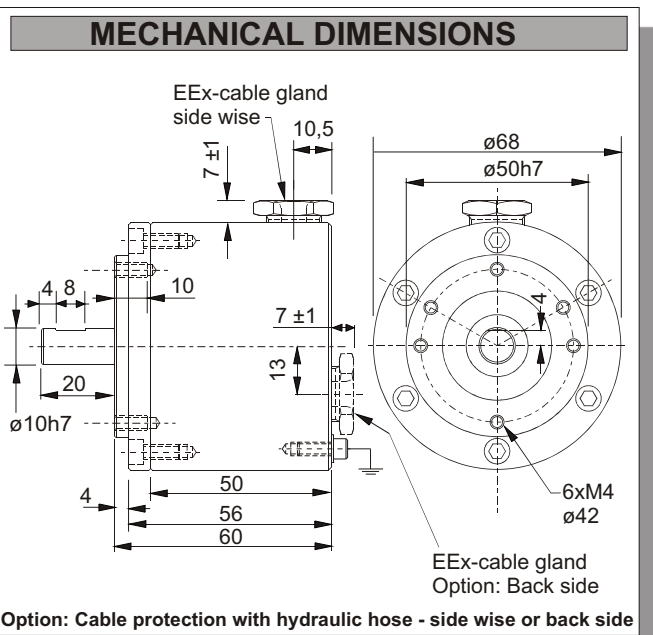

OUTPUT CIRCUIT

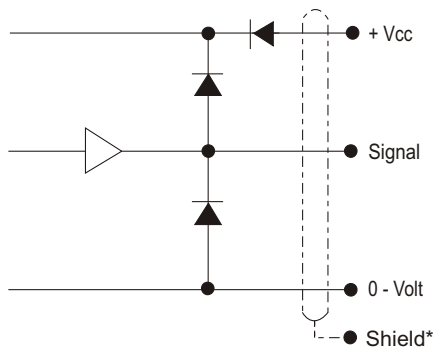

* Shield connected to housing

PULSES/REV.

1	16	50	125	400	1000	2500
2	20	60	150	455	1024	3000
5	25	64	180	500	1131	3600
6	30	75	200	600	1250	4000
8	32	80	250	635	1500	4096
10	36	90	300	720	2000	5000
15	40	100	360	800	2048	9000

ORDERING CODES

	Options	Ordering codes
Pulses pr. rev.:	No. of pulses	XXXXX
Material:	Aluminum	AL
Output signal:	Normal, Standard, A, B, Z (3 channel)	N
	Inverted (A-inv, B-inv, Z-inv)	I
	Differential: A, B, Z and A-inv, B-inv, Z-inv (6 channel)	D
	Line driver OL 7272 for extra long cable, up to 100 meters (Differential)	M
	Line driver chip 26C31 (V out low < 0,4 V) (RS-422A compatible @ 5V) Only 5 Volt (Differential)	L
Shaft dimensions:	ø10 mm	10
IP-rating:	IP 66	66
Length of cable:	Standard 1 meter	01
	No. of meters	XX
Cable take out:	Side-standard	SS
	Back-standard	BS
	Side for hydraulic hose	SH
	Back for hydraulic hose	BH
Face Mount:	20mm shaft length Flange type: standard	A
	27mm shaft length Flange type : standard	C
	20mm shaft length Flange type : standard	K

FACE MOUNT

Face A

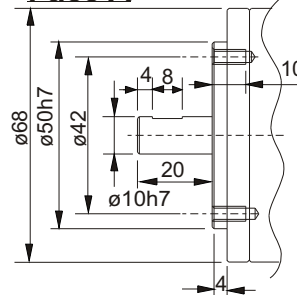

Face C

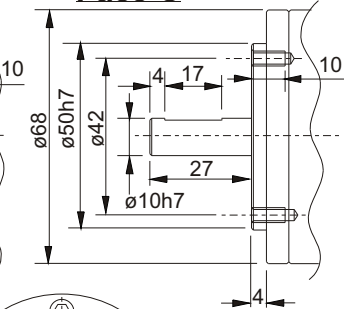

Face A and C
view from front

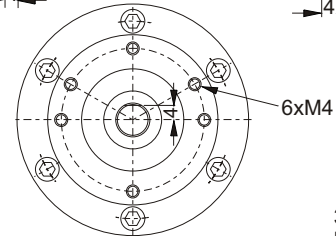

Face K

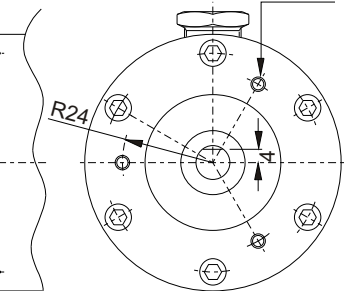
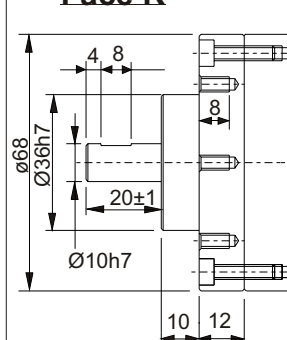

EEx CABLE TAKE OUT

Standard

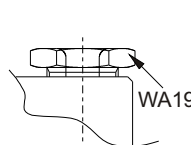

Cable protection with Hydraulic Hose

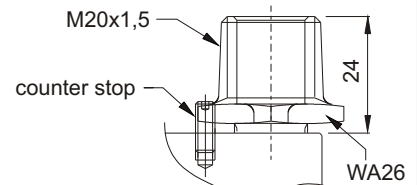

CONNECTIONS

Color code	Standard
Pink	Ch. A
Grey*	Ch. A Gnd
Green	Ch. B
Yellow*	Ch. B Gnd
White	Ch. Z
Brown*	Ch. Z Gnd
Red	Vcc
Blue*	Gnd

*Blue, grey, yellow and brown are internally connected

Color code	Differential
Pink	Ch. A
Grey	Ch. A inv.
Green	Ch. B
Yellow	Ch. B inv.
White	Ch. Z
Brown	Ch. Z inv.
Red	Vcc
Blue	Gnd

2REX-A



Pulses



Material



Output signal



Shaft



IP-rating



Length of cable



Cable take out



Face mount